

Silicon Controlled Rectifier series

1 Description

2P4M Micro trigger series of silicon controlled rectifiers, with high ability to withstand the shock loading of large current, provide high dv/dt rate with strong resistance to electromagnetic interference. They are especially recommended for use on solid state

2 Features

- High current output up to 2A
- Low Peak on-state voltage drop
- High voltage
- High reliability

3 Applications

- Solid state switches etc ·
- Automatic gas lighter, battery charger ·
- For capacitive discharge ignitions, motor control
- in kitchen aids, over voltage crowbar protection
- in low power supplies applications

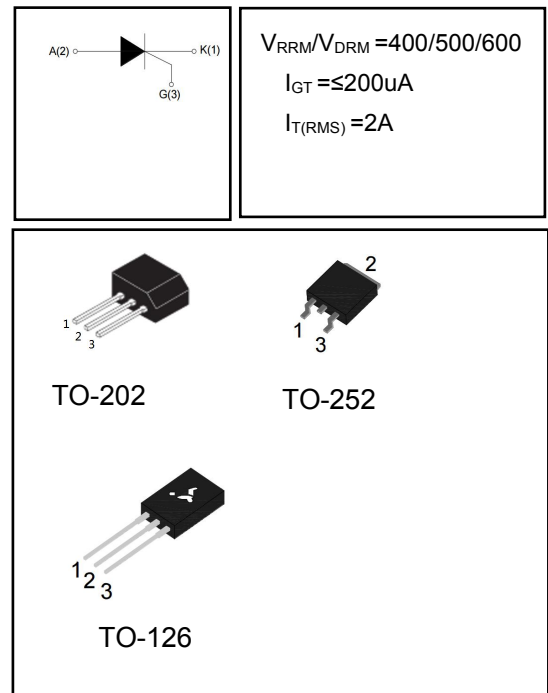

4 Electrical Characteristics

4.1 Absolute Maximum Ratings (Tc=25°C, unless otherwise noted)

PARAMETER	SYMBOL	VALUE	UNIT
Repetitive peak off-state voltage (Tj=25°C)	V_{DRM}	400/600	V
Repetitive peak reverse voltage (Tj=25°C)	V_{RRM}	400/600	V
RMS on-state current	$I_{T(RMS)}$	2	A
Non repetitive surge peak Off-state voltage	V_{DSM}	+ 100	V
Non repetitive peak reverse voltage	V_{RSM}	+ 100	V
Non repetitive surge peak on-state current	I_{TSM}	tp=8.3ms	25
		tp=10ms	20
I ² t value for fusing (tp=10ms)	I ² t	2	A
Repetitive rate of rise of on-state current (IG=2×IGT)	dIT/dt	50	A/us
Peak gate current	I_{GM}	0.2	A
Peak gate power	P_{GM}	0.5	W
Average gate power dissipation	$P_{G(AV)}$	0.1	W
Operating junction temperature range	T _J	- 40 ~ 125	°C
Storage junction temperature range	T _{STG}	- 40 ~ 150	°C

4.2 Thermal Characteristics

PARAMETER	SYMBOL	VALUE	UNIT
Thermal Resistance, Junction to Case-sink	R _{thJC}	10	°C/W

4.3 Electrical Characteristics (Tc=25°C, unless otherwise noted)

SYMBOL	PARAMETER	Test Conditions	Min	Typ	Max	Unit
I _{GT}	Triggering gate current	V _D =12V R _L =33Ω	-	30	200	uA
V _{GT}	Triggering gate voltage		-	0.5	0.8	V
V _{GD}	Non-triggering gate voltage	V _D =V _{DRM} T _j =125°C R _L =3.3KΩ	0.2	-	-	V
I _L	Latching Current	I _G =1.2I _{GT}	-	0.3	3	mA
I _H	Holding Current	I _T =500mA	-	-	2	mA
dV/dt	Critical Rate of Rise of Off-state Voltage	V _D =2/3V _{DRM} Gate Open T _j =125°C	10	-	-	V/us
V _{TM}	Peak Forward On-State Voltage	I _{TM} =4A tp=380us	-	1.32	1.7	V
I _{DRM}	Maximum forward or reverse leakage current	V _D =V _{DRM} V _R =V _{RRM}	T _j =25°C		10	uA
I _{RRM}	Maximum reverse leakage current		T _j =125°C		500	uA

5 Typical characteristics diagrams

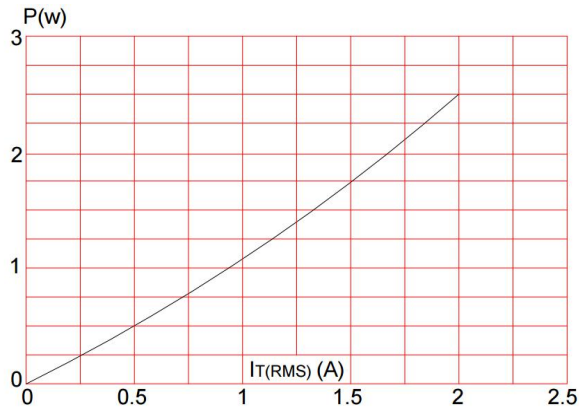

FIG.1: Maximum power dissipation versus RMS on-state current

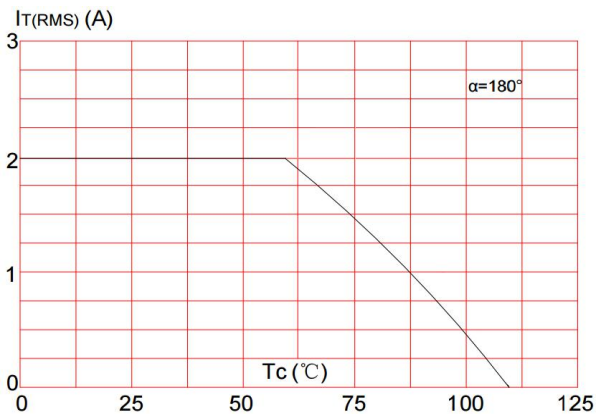

FIG.2: RMS on-state current versus case temperature

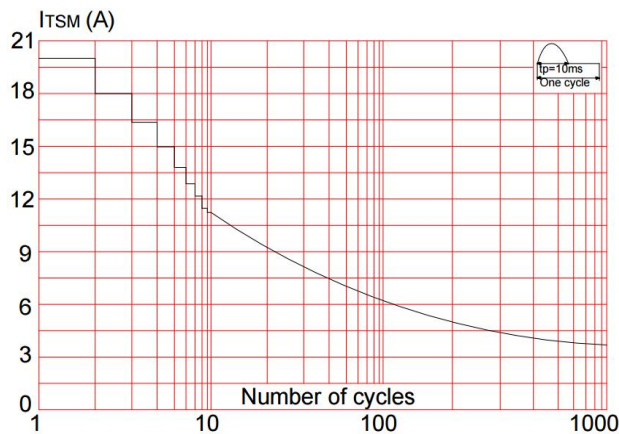

FIG.3: Surge peak on-state current versus number of cycles

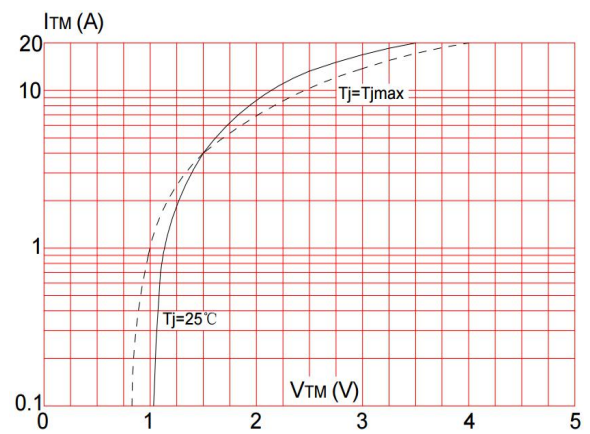

FIG.4: On-state characteristics (maximum values)

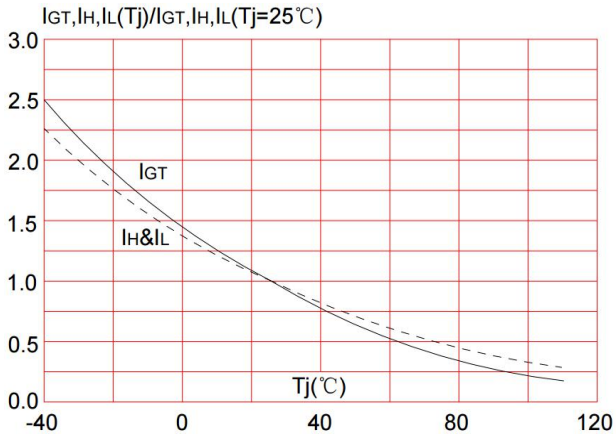

FIG.5: Relative variations of gate trigger current, holding current and latching current versus junction temperature

6 Product Names Rules



Rated Current Code
With 1 Digital,
For Example:
2 on behalf of $I_T(RSM)=2A$

Rated Voltage Code
With 1 Digital, For Example:
4 on behalf of 400V,
5 on behalf of 500V,
6 on behalf of 600V

7 Product Specifications and Packaging Models

Product Model	Package Type	Mark Name	RoHS	Package	Quantity
2P4M	TO-252	W2P4M	Pb-free	Tube	3000//disc
2P4M	TO-126	2P4M	Pb-free	Tube	200//bag

8 Dimensions

TO-126 PACKAGE OUTLINE DIMENSIONS

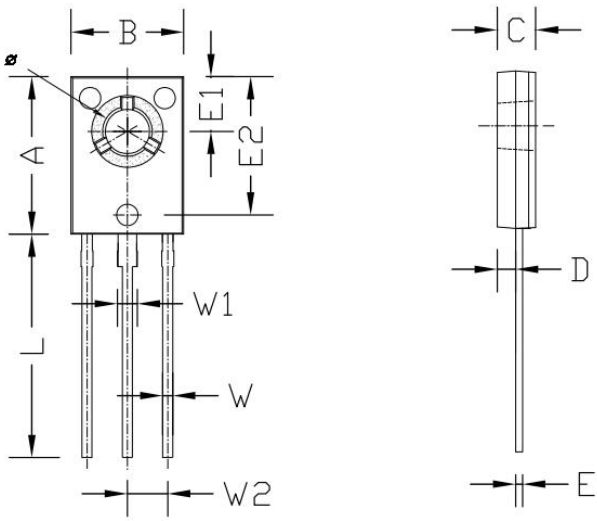

Symbol	Dimensions In Millimeters		Dimensions In Inches	
	min.	max.	min.	max.
A	10.50	11.10	0.413	0.437
B	7.65	7.95	0.301	0.313
C	2.50	2.80	0.098	0.110
D	1.45	1.75	0.057	0.069
E	0.40	0.60	0.016	0.024
E1	3.65	3.85	0.144	0.152
E2	9.40	9.60	0.370	0.378
L	15.4	15.9	0.606	0.626
W	0.60	0.80	0.024	0.031
W1	1.20	1.30	0.047	0.051
W2	2.32 TYP		0.091 TYP	
Φ	3.05	3.35	0.120	0.132

TO-252 PACKAGE OUTLINE DIMENSIONS

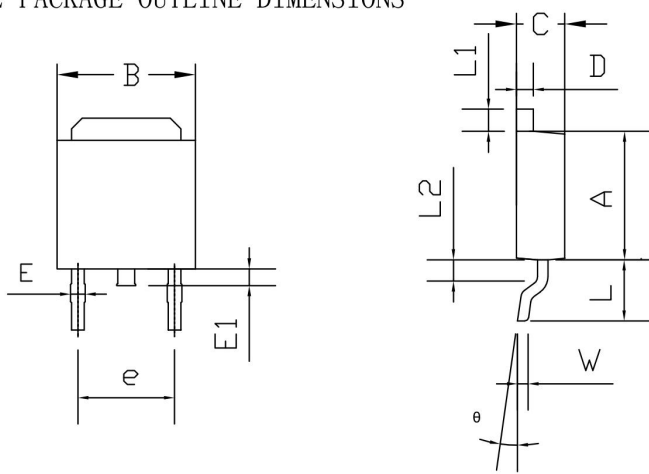

Symbol	Dimensions In Millimeters		Dimensions In Inches	
	min.	max.	min.	max.
A	5.70	6.30	0.224	0.248
B	6.30	6.90	0.248	0.272
C	2.05	2.55	0.081	0.100
D	0.70	0.90	0.028	0.035
E	0.40	0.60	0.016	0.024
E1	0.60	1.00	0.024	0.039
e	4.50	4.65	0.177	0.183
L	2.75	3.05	0.108	0.120
L1	0.75	1.15	0.030	0.045
L2	0.75	1.25	0.030	0.049
W	0.40	0.60	0.016	0.024
θ	0	8	0	8

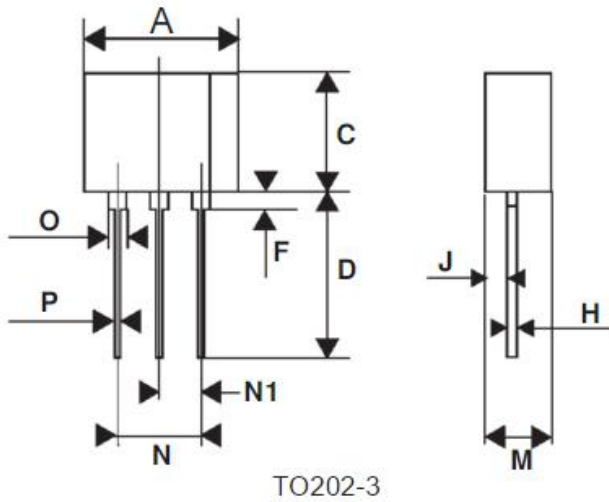

REF.	DIMENSIONS			
	Millimeters		Inches	
	Typ.	Max.	Typ.	Max.
A		10.1		0.398
C	7.3		0.287	
D	10.5		0.413	
E	7.4		0.290	
F		1.5		0.059
H	0.51		0.020	
J	1.5		0.059	
M	4.5		0.177	
N		5.3		0.209
N1	2.54		0.100	
O		1.4		0.055
P		0.7		0.028

9 Attentions

- Jiangsu Donghai Semiconductor Technology Co., Ltd. reserves the right to change the specification without prior notice! The customer should obtain the latest version of the information before making the order and verify that the information is complete and up to date.
- It is the responsibility of the purchaser for any failure or failure of any semiconductor product under certain conditions. It is the responsibility of the purchaser to comply with safety standards and to take safety measures in the system design and machine manufacturing of WXDH products in order to avoid potential risk of failure. Injury or property damage.
- Product promotion is endless, our company will be dedicated to provide customers with better products.

10 Appendix

Revision history:

Date	REV.	Description	Page
2017.09.02	1.0	Original	